

GCE

Chemistry A

Unit **H432/01**: Periodic table, elements and physical chemistry

Advanced GCE

Mark Scheme for June 2018

OCR (Oxford Cambridge and RSA) is a leading UK awarding body, providing a wide range of qualifications to meet the needs of candidates of all ages and abilities. OCR qualifications include AS/A Levels, Diplomas, GCSEs, Cambridge Nationals, Cambridge Technicals, Functional Skills, Key Skills, Entry Level qualifications, NVQs and vocational qualifications in areas such as IT, business, languages, teaching/training, administration and secretarial skills.

It is also responsible for developing new specifications to meet national requirements and the needs of students and teachers. OCR is a not-for-profit organisation; any surplus made is invested back into the establishment to help towards the development of qualifications and support, which keep pace with the changing needs of today's society.







This mark scheme is published as an aid to teachers and students, to indicate the requirements of the examination. It shows the basis on which marks were awarded by examiners. It does not indicate the details of the discussions which took place at an examiners' meeting before marking commenced.

All examiners are instructed that alternative correct answers and unexpected approaches in candidates' scripts must be given marks that fairly reflect the relevant knowledge and skills demonstrated.

Mark schemes should be read in conjunction with the published question papers and the report on the examination.

© OCR 2018

Annotations

Annotation	Meaning
DO NOT ALLOW	Answers which are not worthy of credit
ALLOW	Answers that can be accepted
()	Words which are not essential to gain credit
—	Underlined words must be present in answer to score a mark
AW	Alternative wording
ORA	Or reverse argument
	Correct response
	Incorrect response
	Omission mark
	Benefit of doubt given
	Contradiction
	Rounding error

SF	Error in number of significant figures
ECF	Error carried forward
L1	Level 1
L2	Level 2
L3	Level 3
NBOD	Benefit of doubt not given
SEEN	Noted but no credit given
I	Ignore

Subject-specific Marking Instructions**INTRODUCTION**

Your first task as an Examiner is to become thoroughly familiar with the material on which the examination depends. This material includes:

- the specification, especially the assessment objectives
- the question paper
- the mark scheme.

You should ensure that you have copies of these materials.

You should ensure also that you are familiar with the administrative procedures related to the marking process. These are set out in the OCR booklet **Instructions for Examiners**. If you are examining for the first time, please read carefully **Appendix 5 Introduction to Script Marking: Notes for New Examiners**.

Please ask for help or guidance whenever you need it. Your first point of contact is your Team Leader.

SECTION A

Question	Answer	Marks	AO element	Guidance
1	C	1	AO2.2	
2	C	1	AO2.2	
3	B	1	AO2.2	
4	D	1	AO2.4	
5	A	1	AO1.2	
6	C	1	AO1.2	
7	D	1	AO2.3	
8	A	1	AO1.1	
9	B	1	AO1.2	
10	C	1	AO2.6	
11	A	1	AO1.2	
12	D	1	AO2.5	
13	B	1	AO1.1	
14	C	1	AO1.1	
15	D	1	AO1.1	
	Total	15		

SECTION B

Question			Answer	Marks	Guidance
16	(a)	(i)	(enthalpy change when) 1 mole of gaseous ions react OR 1 mole of hydrated/aqueous ions are formed ✓ gaseous ions dissolve in water OR gaseous ions form aqueous/hydrated ions ✓	2	IGNORE 'energy released' OR 'energy required'
	(a)	(ii)	<p> $\text{Ca}^{2+}(\text{g}) + 2\text{F}^{-}(\text{g})$ ✓ $\text{Ca}^{2+}(\text{aq}) + 2\text{F}^{-}(\text{g})$ ✓ $\text{Ca}^{2+}(\text{aq}) + 2\text{F}^{-}(\text{aq})$ ✓ $\text{CaF}_2(\text{s})$ ✓ </p>	4	<p>Correct species AND state symbols required for each mark. (mark independently)</p> <p>On 2nd line, ALLOW $\text{Ca}^{2+}(\text{g}) + 2\text{F}^{-}(\text{aq})$ (i.e. F^{-} hydrated before Ca^{2+})</p> <p>On 3rd line, ALLOW $\text{CaF}_2(\text{aq})$</p> <p>DO NOT ALLOW when first seen but ALLOW ECF for '2' missing and for use of the following ions Fl^{-} F_2^{-} $\text{Ca}^{+/3+}$</p>

Question		Answer	Marks	Guidance
(a)	(iii)	<p>FIRST, CHECK THE ANSWER ON ANSWER LINE IF answer = $-504 \text{ (kJ mol}^{-1}\text{)}$ award 2 marks IF answer = $-1008 \text{ (kJ mol}^{-1}\text{)}$ award 1 mark</p> <p>-----</p> <p>$2 \times \Delta_{\text{hyd}}H(\text{F}^-)$ $= [-2630 + 13] - (-1609)$ OR $-2617 + 1609$ OR $-1008 \text{ (kJ mol}^{-1}\text{)}$ ✓</p> <p>$\Delta_{\text{hyd}}H(\text{F}^-) = \frac{-1008}{2} = -504 \text{ ✓ (kJ mol}^{-1}\text{)}$</p>	2	<p>IF alternative answer, check to see if there is any ECF credit possible using working below.</p> <p>'-' sign is needed.</p> <p>COMMON ERRORS for 1 mark: (+)2694: <i>signs all reversed</i> -2113: <i>sign wrong for -1609</i> -2126: <i>sign wrong for 2630</i> -517: <i>sign wrong for 13</i> +504: <i>sign wrong</i></p> <p>IF ALL 3 relevant values from the information at the start of Q16a(iii) have NOT been used, award zero marks unless one number has a transcription error, where 1 mark can be awarded ECF</p>
(a)	(iv)	<p>Correct comparison of Δ_{hyd} linked to sizes $\Delta_{\text{hyd}}H(\text{F}^-)$ more negative/exothermic (than $\Delta_{\text{hyd}}H(\text{Cl}^-)$) AND F^- has smaller size (than Cl^-) ✓</p> <p>Comparison of attraction between ions and water F^- OR smaller sized ion linked to greater attraction to H_2O ✓</p>	2	<p>ORA IGNORE 'atomic' before radius when comparing size of ions IGNORE charge density</p> <p>IGNORE electronegativity IGNORE nuclear attraction DO NOT ALLOW 'forms stronger hydrogen bonds with water' OR 'forms stronger van der Waals' forces with water' ALLOW 'forms bonds' for attraction' DO NOT ALLOW F^- greater attraction to H_2O if given as larger ion Assume 'F' / 'Fluorine' means 'ions' but DO NOT ALLOW 'F molecules'</p>

Question		Answer	Marks	Guidance
	(b) (i)	<p>Average bond enthalpy</p> <p>Breaking of one mole of bonds ✓</p> <p>In gaseous molecules ✓</p>	2	<p>IGNORE energy required OR energy released IGNORE heterolytic / homolytic</p> <p>DO NOT ALLOW bonds formed</p> <p>DO NOT ALLOW ionic bonds</p> <p>IGNORE species for molecules</p>
	(b) (ii)	<p>FIRST, CHECK ANSWER ON ANSWER LINE</p> <p>IF answer = (+) 158 award 3 marks</p> <p>-----</p> <p>Bond enthalpy of F–F</p> <p>(ΔH for (O–H) bonds broken =) 1856 OR 4×464 (kJ mol⁻¹) ✓</p> <p>(ΔH for bonds made =) 2770 (kJ mol⁻¹) OR 498 AND 2272 (kJ mol⁻¹) OR 498 AND 4×568 (kJ mol⁻¹) ✓</p> <p>(bond enthalpy) F–F = $\frac{2770 - 1856 - 598}{2}$ = (+)158 (kJ mol⁻¹) ✓</p>	3	<p>ANNOTATE ANSWER WITH TICKS AND CROSSES</p> <p>IGNORE sign</p> <p>IGNORE sign</p> <p>ALLOW ECF</p> <p>Common errors</p> <p>Award 2 marks for; –158 (Wrong sign) (±)316 (No ÷ 2) (+) 622 (use of 2×464) (+) 457 (omitting – 598) (+) 756 (use of +598)</p> <p>Award 1 mark for; (+) 970 (use of 2×464 and +598)</p>
		Total	15	

Question	Answer	Marks	Guidance
17 (a)*	<p><i>Please refer to the marking instructions on page 5 of this mark scheme for guidance on how to mark this question.</i></p> <p>Level 3 (5–6 marks) A comprehensive conclusion which uses quantitative results for determination of the reaction orders. AND Determines k from correct rate equation. AND Proposes the two-step mechanism which adds up to overall equation <i>with no intermediate electrons</i>.</p> <p><i>There is a well-developed line of reasoning which is clear and logically structured. The information presented is relevant and substantiated. The working for the scientific content is clearly linked to the experimental evidence.</i></p> <p>Level 2 (3–4 marks) Reaches a sound, but not comprehensive, conclusion based on the quantitative results. AND Correctly identifies the orders and rate equation. AND Calculates the rate constant OR Proposes the two-step mechanism with reactants of first step matching rate equation or matches orders</p> <p><i>There is a line of reasoning presented with some structure. The information presented is relevant and supported by some evidence. The working for the scientific content is clearly linked to the experimental evidence.</i></p>	6	<p>Indicative scientific points may include:</p> <p>Orders and rate equation</p> <ul style="list-style-type: none"> Fe³⁺ 1st order AND I⁻ 2nd order OR $rate = k[Fe^{3+}][I^-]^2$ Supported by experimental results <p>Calculation of k, including units</p> <ul style="list-style-type: none"> k correctly calculated AND correct units, e.g. $k = \frac{8.10 \times 10^{-4}}{(4.00 \times 10^{-2}) \times (3.00 \times 10^{-2})^2} = 22.5$ dm⁶ mol⁻² s⁻¹ OR mol⁻² dm⁶ s⁻¹ <p>Two-step mechanism</p> <ul style="list-style-type: none"> Two steps add up to give overall equation Slow step/ rate-determining step matches stoichiometry of rate equation. Each step balances by species and charge <p>e.g. $Fe^{3+}(aq) + 2I^{-}(aq) \rightarrow [FeI_2]^{+}$ SLOW $Fe^{3+}(aq) + [FeI_2]^{+} \rightarrow 2Fe^{2+}(aq) + I_2(aq)$ FAST</p> <p>$Fe^{3+}(aq) + 2I^{-}(aq) \rightarrow Fe^{2+}(aq) + I_2^{-}(aq)$ SLOW $Fe^{3+}(aq) + I_2^{-}(aq) \rightarrow Fe^{2+}(aq) + I_2(aq)$ FAST</p> <p>$Fe^{3+}(aq) + 2I^{-}(aq) \rightarrow Fe^{+} + I_2$ SLOW $Fe^{3+}(aq) + Fe^{+} \rightarrow 2Fe^{2+}(aq)$ FAST</p> <p>There may be other feasible possibilities</p>

Question	Answer	Marks	Guidance
	<p>Level 1 (1–2 marks) Attempts to reach a simple conclusion for orders AND Attempts a relevant rate equation.</p> <p><i>There is an attempt at a logical structure with a line of reasoning. The information is in the most part relevant The working for the scientific content is clearly linked to the experimental evidence.</i></p> <p>0 marks No response or no response worthy of credit.</p>		

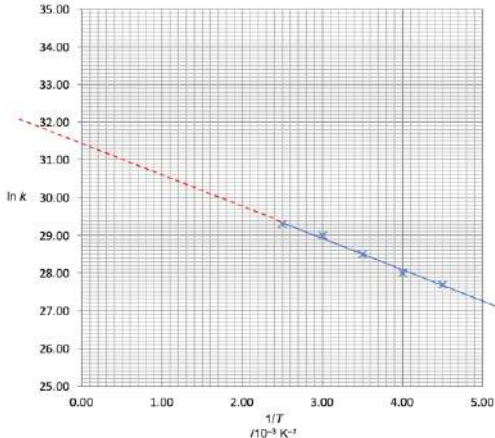
Question	Answer	Marks	Guidance
(b) (i)	 <p>Gradient Correct gradient calculated from best-fit straight line drawn within the range $\pm 800 \rightarrow \pm 1040$ ✓</p> <p>E_a calculation $E_a = (-) \text{ gradient} \times 8.314$ ✓ e.g. from ± 820, $E_a = (+)6817.48$ (J mol⁻¹)</p> <p>E_a to 3 SF AND use of 10^{-3} for gradient ✓ e.g. from ± 820, $E_a = (+)6820$ (J mol⁻¹)</p>	3	<p>ALLOW lines which do not intercept y-axis</p> <p>ALLOW mark for gradient if correct working shown within E_a calculation without gradient being calculated separately</p> <p>ALLOW $\pm 0.8(00) \rightarrow \pm 1.04(0)$ (omission of 10^{-3})</p> <p>ALLOW ECF for calculated gradient x 8.314 If value of gradient not shown separately, ALLOW E_a in range: 6650 \rightarrow 8650 OR 6.65 \rightarrow 8.65 (omission of 10^{-3})</p> <p>This mark subsumes gradient mark</p> <p>NOTE: Omission of 10^{-3} can get 1st 2 marks</p>

Question	Answer	Marks	Guidance
	<p>(ii) Intercept shown on graph could be by extrapolation of line, or label on y axis AND ln A linked to intercept value e.g. $\ln A = 31.4$ ✓</p> <p>Calculation of $A = e^{\text{intercept}}$ ✓ e.g. $A = e^{31.4} = 4.33 \times 10^{13}$</p>	2	<p>ALLOW $y = 31.4$</p> <p>ALLOW substitution of correct values of ln k and 1/T into $\ln k = -E_a/R \times 1/T + \ln A$ to give a value of ln A which approximately matches the intercept if given</p> <p>$\ln A = \ln k + (E_a/R \times 1/T)$</p> <p>Calculation of $A = e^{\ln A}$ OR $e^{\ln k + (E_a/R \times 1/T)}$</p> <p>ALLOW ECF from incorrect ln A</p> <p>$e^{31.2} = 3.55 \times 10^{13}$ $e^{31.3} = 3.92 \times 10^{13}$ $e^{31.35} = 4.12 \times 10^{13}$ $e^{31.45} = 4.56 \times 10^{13}$ $e^{31.5} = 4.79 \times 10^{13}$ $e^{31.6} = 5.29 \times 10^{13}$ $e^{31.7} = 5.85 \times 10^{13}$ $e^{31.8} = 6.46 \times 10^{13}$ $e^{31.9} = 7.14 \times 10^{13}$ $e^{32.0} = 7.9(0) \times 10^{13}$ $e^{32.1} = 8.73 \times 10^{13}$</p> <p>IF 2 DP answer given, check rounding from calculator value, not 3 DP values given Eg $e^{31.7} = 5.8497 \times 10^{13}$ and $= 5.8 \times 10^{13}$ (2SF)</p>
	Total	11	

Question		Answer	Marks	Guidance
18	(a)	$K_c = \frac{[\text{NO}_2]^2}{[\text{NO}]^2 [\text{O}_2]} \checkmark$ <p>Units = $\text{dm}^3 \text{mol}^{-1} \checkmark$</p>	2	<p>Must be square brackets IGNORE state symbols</p> <p>ALLOW $\text{mol}^{-1} \text{dm}^3$ ALLOW mol dm^{-3} as ECF from inverted K_c expression</p>
	(b)	<p>FIRST CHECK THE ANSWER ON THE ANSWER LINE IF answer = 1.2 (mol) award 4 marks</p> <p>Unless otherwise stated, marks are for correctly calculated values. Working shows how values have been derived.</p> <p>$[\text{NO}] = \frac{0.40}{4.0} = 0.1(0) \text{ (mol dm}^{-3}\text{)}$ AND $[\text{O}_2] = \frac{0.80}{4.0} = 0.2(0) \text{ (mol dm}^{-3}\text{)} \checkmark$</p> <p>$[\text{NO}_2]^2 = 45 \times 0.10^2 \times 0.20 \text{ OR} = 0.09(0) \checkmark$ $[\text{NO}_2] = \sqrt{(45 \times 0.10^2 \times 0.20)} \text{ OR} = 0.3(0) \text{ (mol dm}^{-3}\text{)} \checkmark$ amount $\text{NO}_2 = 0.30 \times 4 = 1.2 \text{ (mol)} \checkmark$</p>	4	<p>ANNOTATIONS MUST BE USED</p> <p>For all parts, ALLOW numerical answers from 2 significant figures up to the calculator value</p> <p>Ignore rounding errors after second significant figure</p> <p>1st mark is for realising that concentrations need to be calculated.</p> <p>ALLOW ECF</p> <p>Correct numerical answer with no working would score all previous calculation marks</p> <p>Making point 2 subsumes point 1</p> <p>Making point 3 subsumes points 2 and 1</p> <p>Common errors 9.6 = 3 marks mol of NO and O₂ used 0.36 = 3 marks mol of NO₂ calculated from $[\text{NO}_2]^2$ 2.4 = 2 marks mol of NO and O₂ used and no mol of NO₂ calculated</p>

Question		Answer	Marks	Guidance
	(c) (i)	Exothermic AND K_p decreases as temperature increases ✓	1	ALLOW K_c for K_p ALLOW Equilibrium shifts to left hand side as temperature increases
	(c) (ii)	Equilibrium shift (Equilibrium position) shifts to right / forward / towards products ✓ Effect of increased pressure on K_p expression Ratio (in K_p expression) decreases OR Denominator/bottom of K_p expression increases more (than numerator/top) ✓ Equilibrium shift (K_p expression) Ratio (in K_p expression) increases to restore K_p OR Numerator/top of K_p expression increases to restore K_p ✓	3	FULL ANNOTATIONS NEEDED ALLOW K_c for K_p throughout the response. ALLOW K_p (initially) decreases for second marking point IF K_p is seen to be restored later in the process. ALLOW more NO_2 / product formed to restore K_p ALLOW ratio adjusts to restore K_p
		Total	10	

Question			Answer	Marks	Guidance
19	(a)	(i)	$K_a = \frac{[H^+][CH_3COO^-]}{[CH_3COOH]}$ ✓	1	IGNORE state symbols Must be square brackets IGNORE expressions with HA or with $[H^+]^2$
		(ii)	<p>FIRST, CHECK ANSWER ON ANSWER LINE IF answer = 4.76 award 3 marks</p> <p>-----</p> <p>$[H^+] = 10^{-pH}$ $= 10^{-2.41} = 3.89 \times 10^{-3} \text{ (mol dm}^{-3}\text{)} \checkmark$</p> <p>$K_a = \frac{[H^+]^2}{[CH_3COOH]} = \frac{(3.89 \times 10^{-3})^2}{0.870}$ $= 1.74 \times 10^{-5} \text{ (mol dm}^{-3}\text{)} \checkmark$</p> <p>$pK_a = -\log K_a = -\log 1.74 \times 10^{-5} = 4.76 \checkmark$</p>	3	<p>ALLOW use of HA and A⁻</p> <p>ALLOW 3 SF up to calculator value of: $3.89045145 \times 10^{-3}$ correctly rounded</p> <p>K_a $1.739725573 \times 10^{-5}$ NOTE: 1.74×10^{-5} is same from unrounded $[H^+]$ calculator value and 3 SF $[H^+]$ value</p> <p>2 DP required</p>
		(iii)	<p>% dissociation = $\frac{[H^+]}{[CH_3COOH]} \times 100$ $= \frac{3.89 \times 10^{-3}}{0.870} \times 100 = 0.447(\%) \checkmark$</p>	1	3 SF required

Question	Answer	Marks	Guidance
(b)	<p>FIRST, CHECK ANSWER ON ANSWER LINE IF answer = 95.9(%) award 4 marks</p> <p>-----</p> <p>$[H^+] = 10^{-pH}$ $= 10^{-13.48} = 3.31 \times 10^{-14} \text{ (mol dm}^{-3}\text{)} \checkmark$</p> <p>[OH⁻] from K_w $= \frac{1.00 \times 10^{-14}}{3.31 \times 10^{-14}} = 0.302 \text{ (mol dm}^{-3}\text{)} \checkmark$</p> <p>Mass of (NaOH) $= 0.302 \times \frac{100}{1000} \times 40.0 = 1.21 \text{ (g)} \checkmark$</p> <p>% of NaOH to 3 SF $= \frac{1.21}{1.26} \times 100 = 95.9 \text{ (%) } \checkmark$</p>	4	<p>ALLOW ECF throughout</p> <p>IGNORE rounding errors beyond 3rd SF throughout</p> <p>ALLOW $3.3 \times 10^{-14} \text{ (mol dm}^{-3}\text{)}$</p> <p>ALLOW 0.30 ALLOW 0.303 if 3.3×10^{-14} used in the first marking point</p> <p>ALLOW pOH method; pOH = 14 – 13.48 = 0.52 $[OH^-] = 10^{-0.52} = 0.302 \text{ (mol dm}^{-3}\text{)}$</p> <p>ALLOW $[OH^-] \times 0.1 \times 40$</p> <p>Rounding $[OH^-]$ to 0.3(0) gives 1.2/1.26 = 95.2% Award 4 marks Rounding $[OH^-]$ to 0.303 gives 1.212/1.26 = 96.2% Award 4 marks</p>

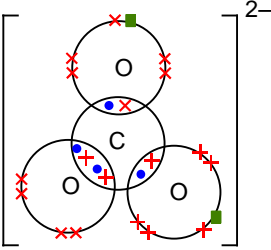
Question	Answer	Marks	Guidance
(c)	<div style="text-align: center;">  </div> <p>Global rules</p> <ul style="list-style-type: none"> • C and O electrons must be shown differently, e.g. • for C and × for O • Na electrons shown with different symbol <p>MARKING</p> <p>Bonding around central C atom ✓</p> <ul style="list-style-type: none"> • 4 electrons for C shown as • OR × • 4 electrons for O, different from C as • OR × • C=O bond with 2 C electrons AND 2 O electrons • Two C–O bonds with 1 C electron AND 1 O electron <p>Non-bonded (nb) electrons around 3 O atoms ✓</p> <ul style="list-style-type: none"> • C=O oxygen has 4 nb ‘O’ electrons • Each C–O oxygen has 5 nb ‘O’ electrons AND 1 ‘extra’ electron with different symbol 	2	<p>NOT REQUIRED</p> <ul style="list-style-type: none"> • Charge (‘2–’) IGNORE incorrect charges • Brackets • Circles <p>IGNORE inner shells</p> <p>ALLOW rotated diagram</p> <p>ALLOW diagram with missing C or O symbols.</p> <p>In C=O bond, ALLOW sequence × × • •</p> <p>In C–O bond, ALLOW ‘extra’ electron with different symbol for O electron</p> <p>ALLOW non-bonding electrons unpaired</p> <p>ALLOW ‘extra’ electron as • OR × if it has been labelled ‘extra electron’ or similar</p>
	Total	11	

Question	Answer	Marks	Guidance
20 (a)	<p>ASSUME trend is down the group (unless stated otherwise)</p> <p>Forces London forces increase OR induced dipole(–dipole) interactions increase ✓</p> <p>Reason (Number of) electrons increases ✓</p> <p>Link to energy and particles More energy to break intermolecular forces OR to break London forces OR to break induced dipole(–dipole) interactions ✓</p>	3	<p>FULL ANNOTATIONS MUST BE USED ----- ALLOW reverse argument throughout</p> <p>IGNORE van der Waals'/vdW forces DO NOT ALLOW hydrogen bonds OR permanent dipole(-dipole) interactions for first and third marking points</p> <p>ALLOW more (electron) shells</p> <p>DO NOT ALLOW covalent bonds break</p>

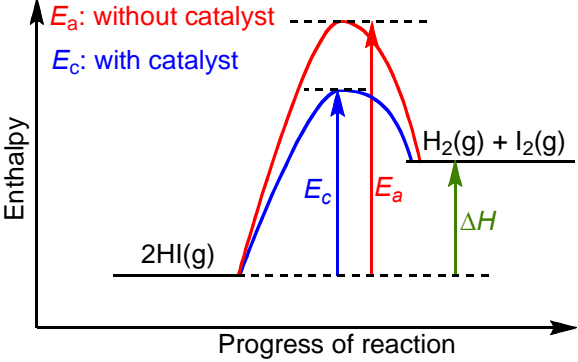
Question	Answer	Marks	Guidance
(b)	 <p>2HI(g) on LHS AND H₂(g) + I₂(g) on RHS ✓</p> <p>ΔH labelled with product above reactant AND arrow upwards ✓</p> <p>E_a AND E_c correctly labelled with E_c below E_a ✓</p>	3	<p>FULL ANNOTATIONS MUST BE USED</p> <p>Mark each point independently</p> <p>IGNORE state symbols.</p> <p>ΔH: DO NOT ALLOW -ΔH. ALLOW ΔH arrow even with a gap at the top and bottom, i.e. does not quite reach reactant or product line</p> <p>E_a: ALLOW no arrowhead or arrowheads at both ends of E_a line E_a line must reach (near or not too far beyond) maximums regardless of position</p> <p>ALLOW AE or EA for E_a</p> <p>Exothermic diagram can access the first and third marks</p>

Question	Answer	Marks	Guidance
(c)	<p>FIRST CHECK THE ANSWER ON THE ANSWER LINE IF $M = 183$ AND Formula = Cl_2O_7 award 4 marks IF $M = 183$ award 3 marks</p> <p>-----</p> <p>Use of data and unit conversions</p> <ul style="list-style-type: none"> • (R = 8.314) • T in K: 373K • V in m^3: 76.0×10^{-6} • (p in Pa: 1.00×10^5) ✓ <p>Calculation of n</p> $n = \frac{(1.00 \times 10^5) \times (76.0 \times 10^{-6})}{8.314 \times 373}$ $n = 2.45 \times 10^{-3} \text{ (mol) } \checkmark$ <p>Molar mass</p> $M = \frac{m}{n} = \frac{0.4485}{2.45 \times 10^{-3}} = 183 \text{ (g mol}^{-1}\text{)} \checkmark$ <p>Molecular formula</p> <p>$\text{Cl}_2\text{O}_7 \checkmark$</p>	4	<p>If there is an alternative answer, check to see if there is any ECF credit possible using working below</p> <p>Correct value of n subsumes first mark</p> <p>ALLOW ECF from incorrectly calculated n</p> <p>ALLOW ECF from incorrect M if formula of Cl_xO_y is the closest to the with calculated value of M</p> <p>IGNORE use of $24\,000 \text{ cm}^3$ for calculation of n BUT then Mark molar mass and Molecular formula by ECF for two marks maximum.</p> $n = \frac{76.0}{24000} = 3.17 \times 10^{-3} \text{ (mol)}$ $M = \frac{0.4485}{3.17 \times 10^{-3}} = 141.6/141.5 \text{ (g mol}^{-1}\text{)} \checkmark$ <p>Molecular formula = $\text{Cl}_3\text{O}_2 \checkmark$</p>

Question		Answer	Marks	Guidance
(d)	(i)	Titres correct and ALL recorded to 2 decimal places Titre: 24.00 23.40 23.75 23.85 ✓ mean titre = 23.80 (cm ³) ✓	2	ALLOW 23.8 cm ³
(d)	(ii)	Percentage uncertainty = $\frac{0.05 \times 2}{23.40} \times 100 = 0.43 (\%)$ ✓	1	ALLOW ECF from incorrect subtraction in (i) or incorrect mean ALLOW 0.42% from titre values 2, 3 or 4 or mean titre or trial titre. 2 DP required
(d)	(iii)	Add starch (near the end point) ✓ Blue to colourless ✓	2	ALLOW blue/black OR black OR purple for colour of mixture ALLOW blue colour disappears (to colourless) IGNORE 'clear' IGNORE 'colorimetry'

Question	Answer	Marks	Guidance
(d) (iv)	<p>FIRST CHECK THE ANSWER ON THE ANSWER LINE IF B = RbIO₃ AND relative formula mass = 260.5 award 5 marks IF relative formula mass = 260.5 award 4 marks</p> <p>-----</p> <p>$n(\text{S}_2\text{O}_3^{2-})$ in titration $= \frac{0.150 \times 23.80}{1000} = 3.57 \times 10^{-3} \text{ (mol) } \checkmark$</p> <p>$n(\text{IO}_3^-)$ in titration $= \frac{3.57 \times 10^{-3}}{6} = 5.95 \times 10^{-4} \text{ (mol) } \checkmark$</p> <p>$n(\text{IO}_3^-)$ in original 250 cm³ $= 10 \times 5.95 \times 10^{-4} = 5.95 \times 10^{-3} \text{ (mol) } \checkmark$</p> <p>Relative formula mass of B $= \frac{1.55}{5.95 \times 10^{-3}} = 260.5 \text{ (g mol}^{-1}\text{) } \checkmark$</p> <p>Formula of B (must be derived from relative formula mass) iodate of Group 1 metal that most closely matches calculated molar mass of B</p> <p>Formula from 260.5 = RbIO₃ ✓</p>	5	<p>ALLOW ECF from incorrect mean titre in (a)(i)</p> <p>ECF from $n(\text{S}_2\text{O}_3^{2-})$ in titration ALLOW a two-step calculation $n(\text{I}_2) = n(\text{S}_2\text{O}_3^{2-}) \div 2$ and $n(\text{IO}_3^-) = n(\text{I}_2) \div 3$</p> <p>ECF from $n(\text{IO}_3^-)$ in titration</p> <p>ECF from $n(\text{IO}_3^-)$ in original 250 cm³ IF scaling $\times 10$ is omitted, ALLOW ECF from $n(\text{IO}_3^-)$ in titration</p> <p>ALLOW ECF from incorrect RFM of B provided metal is from Group 1 ALLOW RbIO₃⁻ DO NOT ALLOW RbIO₃ without relative formula mass value. DO NOT ALLOW 260.4 (without working) and RbIO₃ IF B = RbIO₃ AND relative formula mass = 261 award 5 marks</p>
	Total	20	

Question		Answer	Marks	Guidance
21	(a)	Ni: $1s^2 2s^2 2p^6 3s^2 3p^6 3d^8 4s^2$ ✓ Ni ²⁺ : $1s^2 2s^2 2p^6 3s^2 3p^6 3d^8$ ✓	2	ALLOW 4s before 3d, ie $1s^2 2s^2 2p^6 3s^2 3p^6 4s^2 3d^8$ ALLOW $1s^2$ written after answer prompt (ie $1s^2$ twice) ALLOW upper case D, etc and subscripts, e.g.4S ₂ 3D ₈ ALLOW for Ni ²⁺4s ⁰ DO NOT ALLOW [Ar] as shorthand for $1s^2 2s^2 2p^6 3s^2 3p^6$ Look carefully at $1s^2 2s^2 2p^6 3s^2 3p^6$ – there may be a mistake
	(b)	(i)	4	Voltmeter must be shown AND salt bridge must be labelled ALLOW small gaps in circuit ALLOW half cells drawn either way around IGNORE 2 before I ⁻ (aq) DO NOT ALLOW I ₂ (g) OR I ₂ (s) OR I ₂ (l) ALL conditions required BUT ALLOW 1 mol dm ⁻³ /1M if omitted here but shown for just one solution in diagram Look on diagram in addition to answer lines IGNORE pressure <i>Not relevant for this cell</i> DO NOT ALLOW 1 mol for concentration
	(b)	(ii)	1	IGNORE sign
	(c)	(i)	1	ALLOW multiples IGNORE state symbols, even if wrong

Question		Answer	Marks	Guidance
(c)	(ii)	<p>Equations</p> $3\text{Zn(s)} + \text{Cr}_2\text{O}_7^{2-}(\text{aq}) + 14\text{H}^+(\text{aq}) \rightarrow 3\text{Zn}^{2+}(\text{aq}) + 2\text{Cr}^{3+}(\text{aq}) + 7\text{H}_2\text{O(l)}$ <p>✓</p> $\text{Zn(s)} + 2\text{Cr}^{3+}(\text{aq}) \rightarrow \text{Zn}^{2+}(\text{aq}) + 2\text{Cr}^{2+}(\text{aq}) \quad \checkmark$ <p>Comparison of E values (seen once)</p> <p>E of Zn is more negative/less positive than E of $\text{Cr}_2\text{O}_7^{2-}$</p> <p>OR</p> <p>E of Zn is more negative/less positive than E of Cr^{3+}</p> <p>✓</p> <p>Equilibrium shift related to E values</p> <p>More negative/less positive OR Zn system shifts left</p> <p>OR</p> <p>Less negative/more positive $\text{Cr}_2\text{O}_7^{2-}$ system shifts right OR Less negative/more positive Cr^{3+} system shifts right ✓</p>	4	<p>ALLOW multiples IGNORE state symbols, even if wrong</p> <p>ALLOW E_{cell} is (+) 2.09V for Zn/$\text{Cr}_2\text{O}_7^{2-}$ cell OR ALLOW E_{cell} is (+) 0.34V for Zn/Cr^{3+} cell IGNORE 'lower/higher'</p> <p>For 'shifts left': ALLOW '(Zn) is oxidised' OR 'electrons are lost (from Zn)'</p> <p>For 'shifts right', ALLOW '(Cr) is reduced' OR 'electrons are gained'</p>

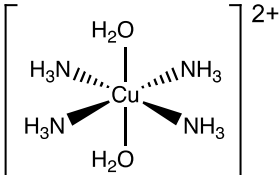
Question	Answer	Marks	Guidance																					
(d)	<p>Please refer to the marking instructions on page 5 of this mark scheme for guidance on how to mark this question.</p> <p>Level 3 (5–6 marks) All three reactions are covered in detail with C, D, E and F identified with clear explanations.</p> <p><i>There is a well-developed line of reasoning which is clear and logically structured with clear chemical communication and few omissions. The information presented is relevant and substantiated.</i></p> <p>Level 2 (3–4 marks) All three reactions are covered but explanations may be incomplete OR Two reactions are explained in detail.</p> <p><i>There is an attempt at a logical structure with a line of reasoning. The information is relevant e.g. formulae may contain missing brackets or numbers and supported by some evidence.</i></p> <p>Level 1 (1–2 marks) Make two simple explanations from any one reaction. OR Makes one simple explanation from each of two reactions</p> <p><i>There is an attempt at a logical structure with a line of reasoning The information is in the most part relevant.</i></p> <p>0 marks No response worthy of credit.</p>	6	<p>Indicative scientific points may include:</p> <p>REACTION 1 (CuSO₄/NH₃) Product C : [Cu(NH₃)₄(H₂O)₂]²⁺ Equation [Cu(H₂O)₆]²⁺ + 4NH₃ → [Cu(NH₃)₄(H₂O)₂]²⁺ + 4H₂O Structure of trans stereoisomer</p>  <p>Correct connectivity</p> <p>REACTION 2 (Cu₂O/H₂SO₄) Products D : CuSO₄ OR [Cu(H₂O)₆]²⁺ E: Cu Equation Cu₂O + H₂SO₄ → CuSO₄ + Cu + H₂O Oxidation numbers Cu(+1) → Cu(+2) + Cu(0)</p> <p>REACTION 3 (CuO/HNO₃) Equation CuO + 2HNO₃ → Cu(NO₃)₂ + H₂O Molar ratios</p> <table style="margin-left: auto; margin-right: auto;"> <tr> <td>Cu</td> <td>:</td> <td>H</td> <td>:</td> <td>N</td> <td>:</td> <td>O</td> </tr> <tr> <td>= 26.29</td> <td>:</td> <td>2.49</td> <td>:</td> <td>11.59</td> <td>:</td> <td>59.63</td> </tr> <tr> <td>= 63.5</td> <td>:</td> <td>1.0</td> <td>:</td> <td>14.0</td> <td>:</td> <td>16.0</td> </tr> </table> <p>Formula of F CuH₆N₂O₉ F: Cu(NO₃)₂•3H₂O (OR Cu(NO₃)₂(H₂O)₃)</p>	Cu	:	H	:	N	:	O	= 26.29	:	2.49	:	11.59	:	59.63	= 63.5	:	1.0	:	14.0	:	16.0
Cu	:	H	:	N	:	O																		
= 26.29	:	2.49	:	11.59	:	59.63																		
= 63.5	:	1.0	:	14.0	:	16.0																		

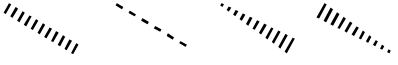
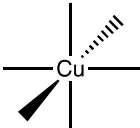
Question			Answer	Marks	Guidance
					<p>-----</p> <p>Further guidance on use of wedges</p> <ul style="list-style-type: none"> • Must contain 2 'out wedges', 2 'in wedges' and 2 lines in plane of paper OR 4 lines, 1 'out wedge' and 1 'in wedge': • For bond into paper, ALLOW:  • ALLOW following geometry: 
			Total	18	

OCR (Oxford Cambridge and RSA Examinations)
The Triangle Building
Shaftesbury Road
Cambridge
CB2 8EA

OCR Customer Contact Centre

Education and Learning

Telephone: 01223 553998

Facsimile: 01223 552627

Email: general.qualifications@ocr.org.uk

www.ocr.org.uk

For staff training purposes and as part of our quality assurance programme your call may be recorded or monitored

Oxford Cambridge and RSA Examinations
is a Company Limited by Guarantee
Registered in England
Registered Office; The Triangle Building, Shaftesbury Road, Cambridge, CB2 8EA
Registered Company Number: 3484466
OCR is an exempt Charity

OCR (Oxford Cambridge and RSA Examinations)
Head office
Telephone: 01223 552552
Facsimile: 01223 552553

© OCR 2018

 **Cambridge
Assessment**

